

OUTLINE DIMENSIONAL DRAWING

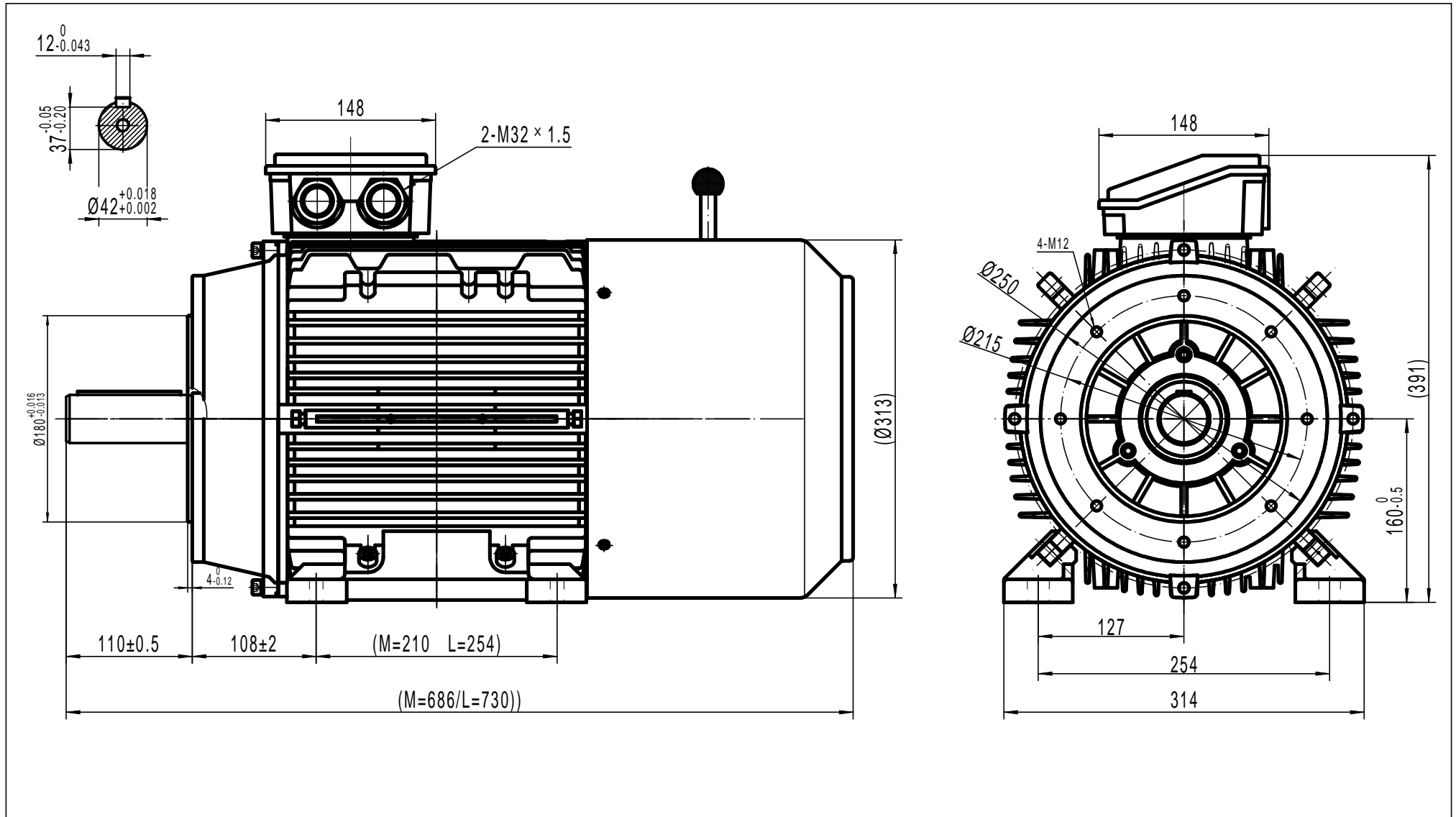

TECHTOP
A U S T R A L I A

TECHTOP AUSTRALIA PTY LTD	
FRAME	TAIB 160A B34
DATE	DRAWING NO.
2013/10/22	1ST107.052.001-032 A